

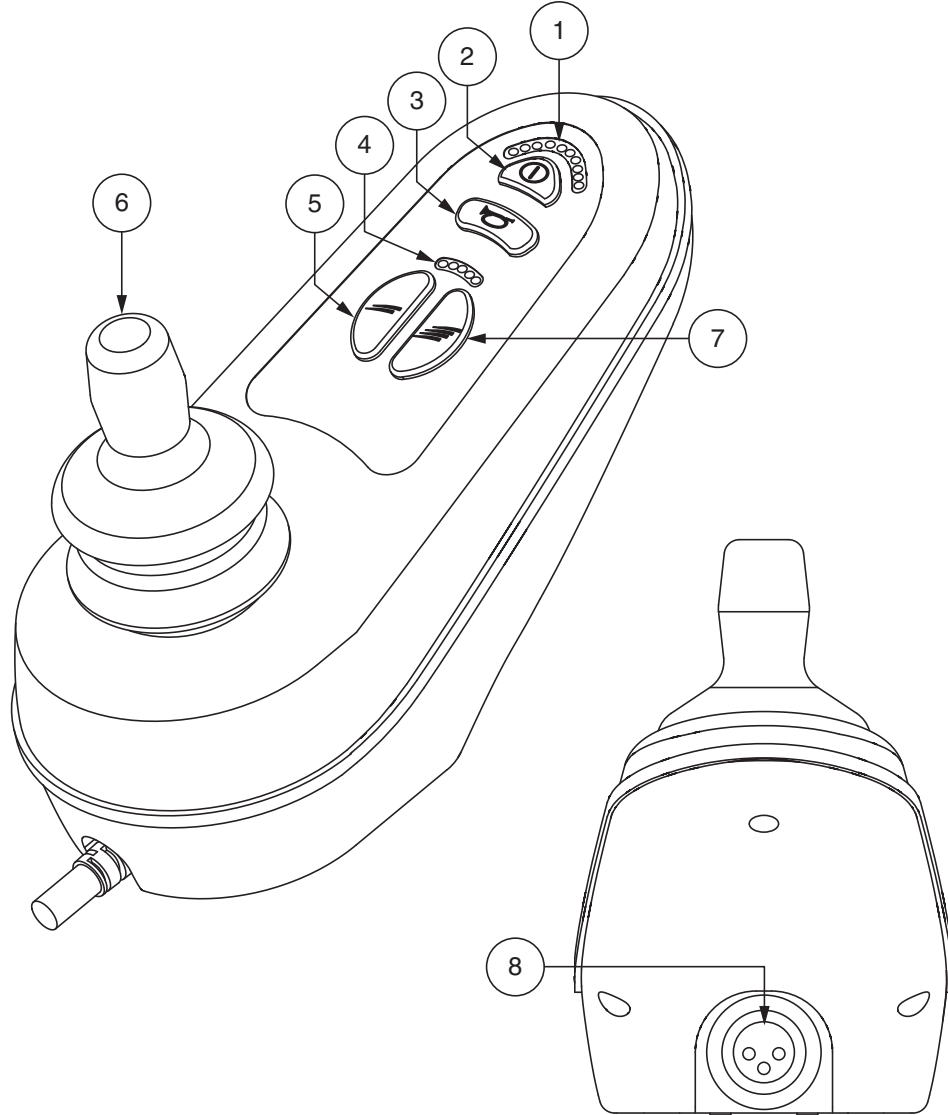

VR2

Identification Key

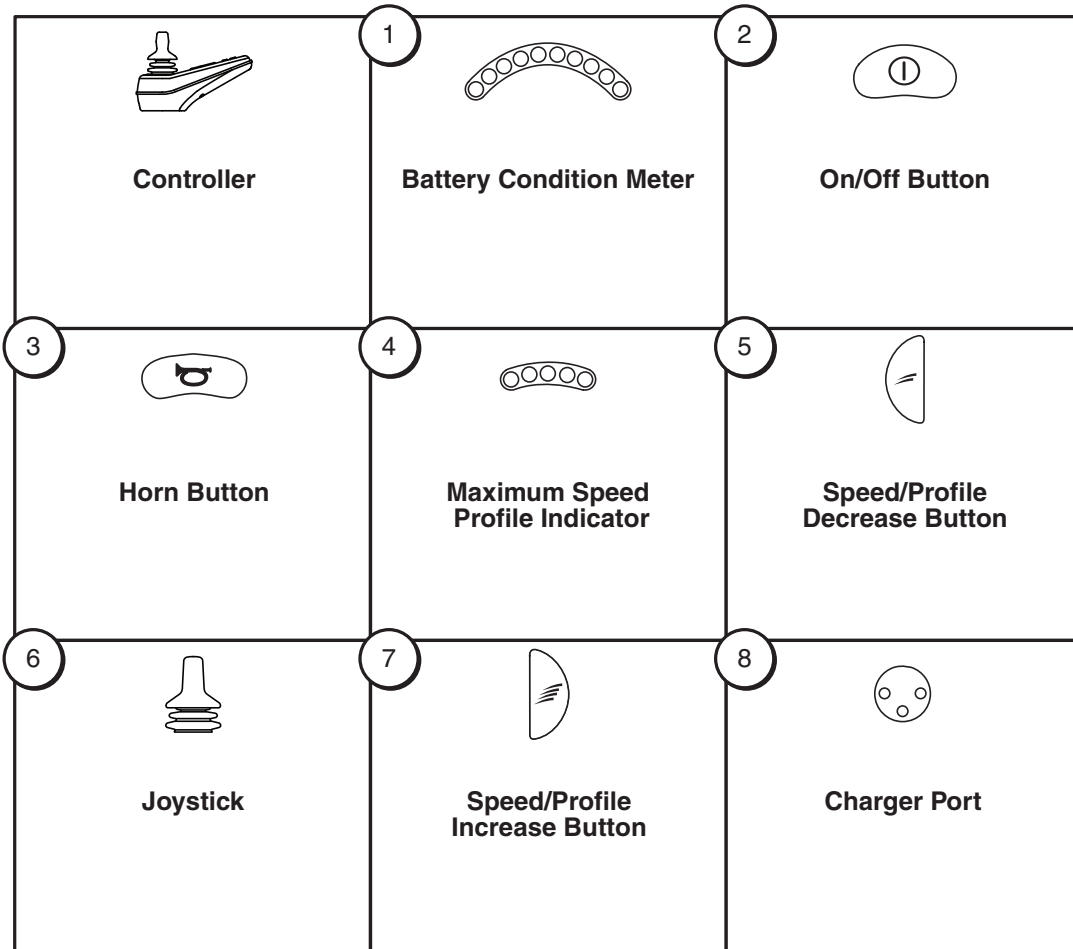





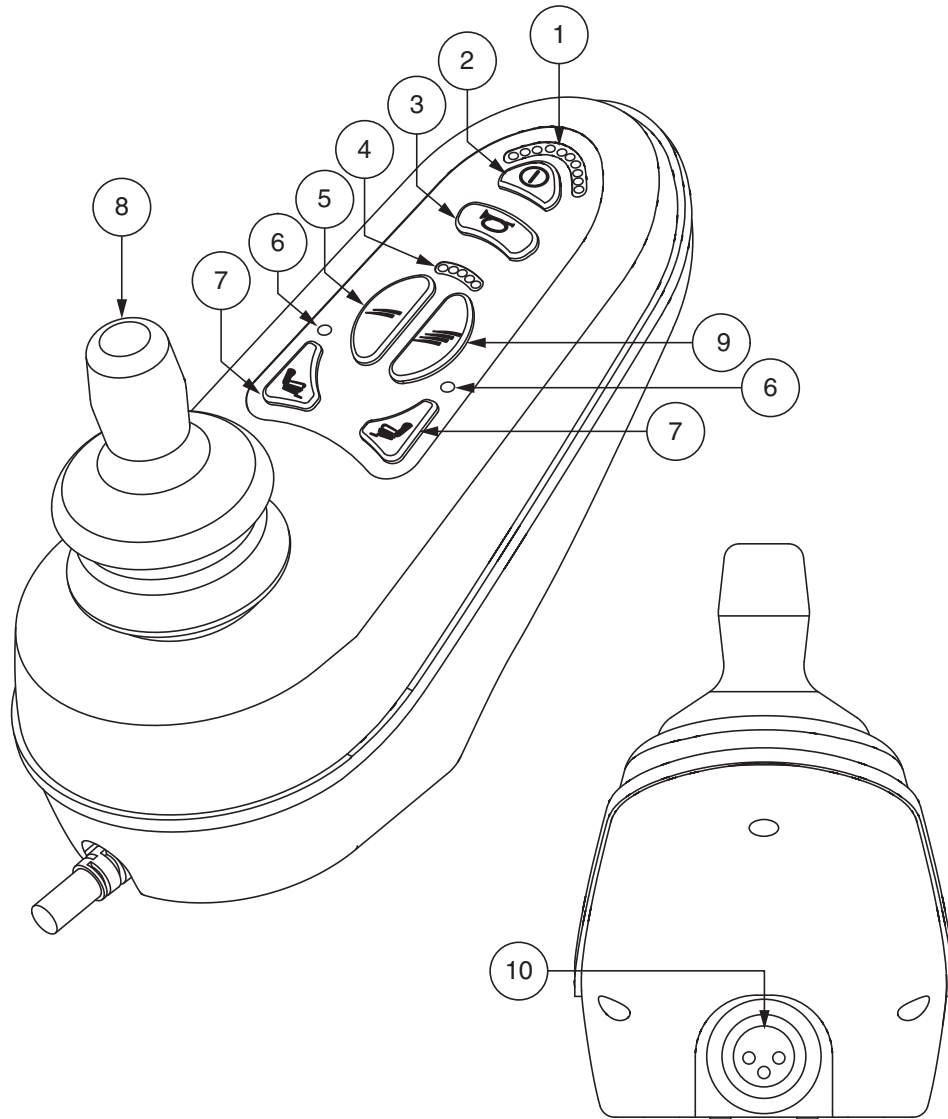

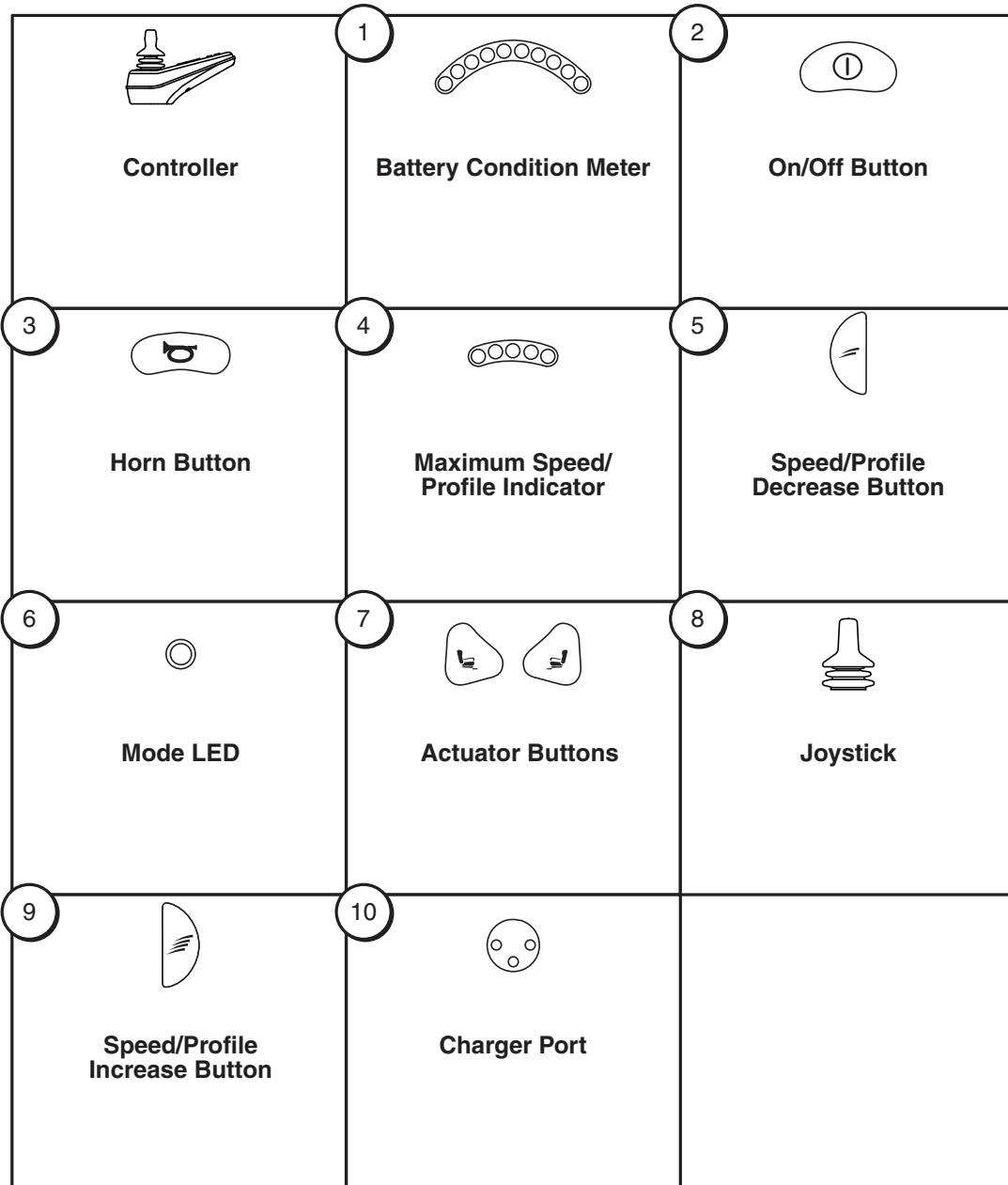



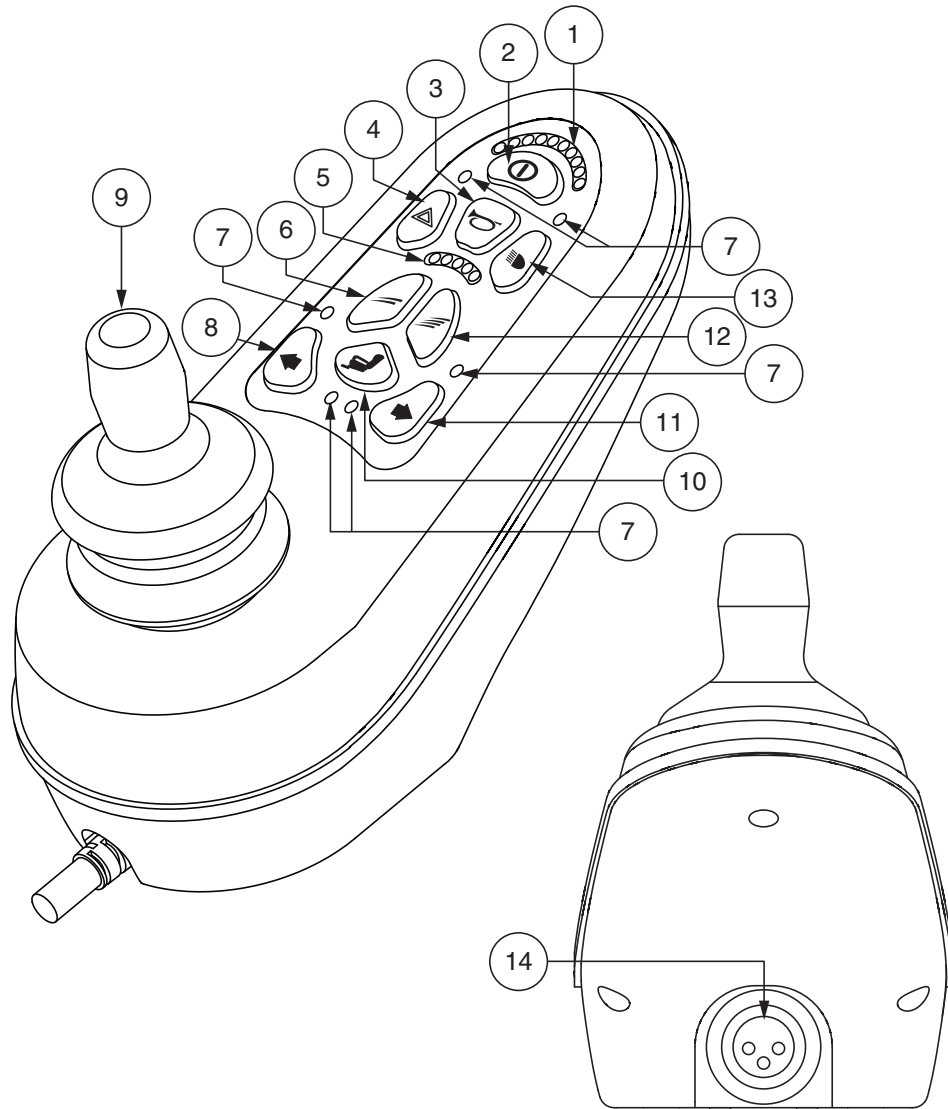

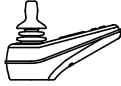



Identification Key





Identification Key



 <p>Controller</p>	 <p>Battery Condition Meter</p>	 <p>On/Off Button</p>
 <p>Horn Button</p>	 <p>Hazard Button</p>	 <p>Maximum Speed/ Profile Indicator</p>
 <p>Speed/Profile Decrease Button</p>	 <p>Mode LED</p>	 <p>Left Turn Indicator Button</p>
 <p>Joystick</p>	 <p>Actuator Button</p>	 <p>Right Turn Indicator Button</p>
 <p>Speed/Profile Increase Button</p>	 <p>Light Button</p>	 <p>Charger Port</p>



WARNING! A Pride/Quantum Rehab Provider or a qualified technician must perform the initial setup of this power chair and must perform all of the procedures in this manual.

The symbols below are used throughout this owner's manual and on the power chair to identify warnings and important information. It is very important for you to read them and understand them completely.



WARNING! Indicates a potentially hazardous condition/situation. Failure to follow designated procedures can cause either personal injury, component damage, or malfunction. On the product, this icon is represented as a black symbol on a yellow triangle with a black border.



MANDATORY! These actions should be performed as specified. Failure to perform mandatory actions can cause personal injury and/or equipment damage. On the product, this icon is represented as a white symbol on a blue dot with a white border.



PROHIBITED! These actions are prohibited. These actions should not be performed at any time or in any circumstances. Performing a prohibited action can cause personal injury and/or equipment damage. On the product, this icon is represented as a black symbol with a red circle and red slash.

NOTE: This owner's manual is compiled from the latest specifications and product information available at the time of publication. We reserve the right to make changes as they become necessary. Any changes to our products may cause slight variations between the illustrations and explanations in this manual and the product you have purchased. The latest/current version of this manual is available on our website.

NOTE: This product is compliant with WEEE, RoHS, and REACH directives and requirements.

NOTE: This product meets IPX4 classification (IEC 60529).

NOTE: The VR2 Controller and its components are not made with natural rubber latex. Consult with the manufacturer regarding any after-market accessories.

Label Information	10
VR2 Controller	11
Precautionary Guidelines	11
Operating the VR2 Controller	11
Controller Communication Connector	13
Actuator Adjustment.....	13
Drive Profile Selection	14
Speed Adjustment.....	14
Lock Mode.....	14
Sleep Mode.....	15
Thermal Rollback.....	15
Error Codes.....	15
Care and Maintenance	16
Temperature.....	16
Warranty	16

Product Safety Symbols

The symbols below are used on the power chair to identify warnings, mandatory actions, and prohibited actions. It is very important for you to read and understand them completely.



Read and follow the information in the owner's manual.



Avoid exposure to rain, snow, ice, salt, or standing water whenever possible. Maintain and store in a clean and dry condition.



EMI/RFI—This product has been tested and passed at an immunity level of 20 V/m.



Disposal and recycling—Contact your Pride/Quantum Rehab Provider for information on proper disposal and recycling of your Pride/Quantum product and its packaging.

VR2 Controller

The VR2 Controller is a fully programmable, modular electronic controller system that allows you to operate your power chair. It is designed to allow the user to have complete control over chair movement and speed.

The controller has been pre-programmed to meet a typical user's needs. The program is set using either a personal computer with software provided by the controller manufacturer or with a hand-held programmer, also provided by the controller manufacturer.



WARNING! The controller program can affect speed, acceleration, deceleration, dynamic stability, and braking. If it is programmed incorrectly or outside of the safe limits as determined by your healthcare professional, it can create a dangerous situation. Only the power chair manufacturer, an authorized representative of the manufacturer, or a trained service technician should program the controller.

Precautionary Guidelines

Before operating the VR2 Controller, please read the following. These guidelines are provided for your benefit and will aid you in the safe operation of the controller system.

- Turn off the power to the controller when transferring to or from your power chair.
- Follow all of the procedures and heed the warnings as explained in your power chair owner's manual.

Operating the VR2 Controller

The VR2 Controller is used to operate your power chair and all of its components.

Joystick Control

The joystick controls the direction and speed of your power chair. When you move the joystick from the neutral (center) position, the electromagnetic brakes release and allow your power chair to move. The farther you push the joystick from its neutral position, the faster your power chair moves. When you release the joystick and allow it to return to the neutral position, you engage the electromagnetic brakes. This causes your power chair to decelerate and come to a complete stop.

Keypad

The keypad is located directly in front of the joystick. It contains keys that you will use to control your power chair.

On/Off Button

The on/off button turns the system on and off.



WARNING! When faced with an emergency stop situation, release the joystick, then press the on/off to stop the power chair. Use caution. Be advised that pressing the on/off button may cause the power chair to stop abruptly.

WARNING! Always turn the power off when you are stationary to prevent unexpected movement.

Speed/Profile Buttons

There are two buttons that control either speed or profiles, depending on your VR2 program. Press the speed/profile increase button to increase the speed or change the profile. Press the speed/profile decrease button to decrease the speed or change the profile. The speed/profile setting is displayed on the maximum speed/profile indicator. If your power chair was programmed with a drive profile, contact your Pride/Quantum Rehab Provider for more information.

NOTE: We recommend that the first few times you operate your power chair, you set the speed to the slowest setting until you become familiar with your new power chair.

Battery Condition Meter

The battery condition meter consists of ten (10) LEDs arranged in an arc over the on/off and horn buttons. See figure 1. The battery condition meter indicates the status of the electrical system using LED codes. For example, as the battery voltage drops, the number of LEDs reduces from right to left. When the battery capacity drops to 10% or below, the left red LED will flash.

Battery condition meter codes are as follows:

- **Left Red LED Flashing Slowly or Steady:** Battery charge is low. Charge the batteries as soon as possible.
- **Step up of LEDs:** The controller is in programming, inhibit, or charging mode.
- **All LEDs Blinking Once Every 2.5 Seconds:** The controller is in sleep mode. Power the controller off and then on again to restart.
- **Lights Ripple Side to Side:** The joystick was not in the center position when the power was switched on. Power the controller off and allow the joystick to return to the neutral position, and then power the controller back on to restart. If the lights are still rippling side to side, contact your authorized Pride/Quantum Rehab Provider.

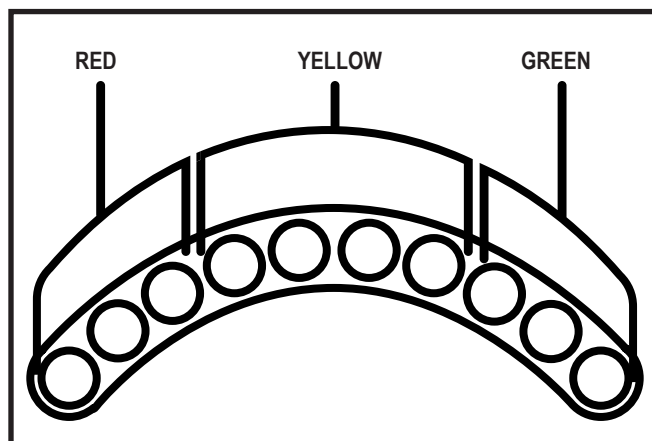

Figure 1. Controller Light Segments

Horn Button

The horn button activates a warning horn.

3-Pin Off-board Charger/Programming Socket

You may use an off-board charger to charge your power chair batteries through the 3-pin socket located on the front of the VR2. If you use an off-board charger, the charger current should not exceed 8 amps. Contact your authorized Pride/Quantum Rehab Provider for more information.



WARNING! Only chargers with Neutrik NC3MX plugs should be connected to the off-board charger/programming socket. See your authorized Pride/Quantum Provider for more information.

NOTE: The socket may also be used for reprogramming the VR2. Contact an Pride/Quantum Rehab Provider for more information.

Actuator Buttons and Actuator Lights (for optional equipment)

Actuator buttons and actuator lights are used for optional equipment such as power elevating seats or power elevating leg rests. For specific operation of the actuator buttons and actuator lights, refer to “Actuator Adjustment.”

Controller Communication Connector

The controller communication connector provides the VR2 with a connection to the power module via an intermediate harness equipped with an onboard/off-board charger connector.



MANDATORY! Prevent controller harness damage! Avoid routing the controller harness on the outside of the armrest pad. Route the harness under the armrest or toward the inside of the armrest pad. Use correct tie-down points for the controller harness to prevent the harness from getting caught in the drive tires, pinched in the seat frame, or damaged when passing through doorways.

Actuator Adjustment

The VR2 Controller can control two actuators using the actuator buttons and the joystick. The active actuator is indicated by an illuminated actuator LED.

NOTE: The 6-key and 9-key controllers operate the actuators differently. Refer to the appropriate instructions for operation.

To select and adjust an actuator using the 6-key controller:

1. Push the on/off button to power on the chair and the controller.
2. Push the desired actuator button to select actuator mode.
3. Push the joystick forward to lower the actuator or backward to raise the actuator to the desired position.
4. Push the actuator select button to return to drive mode.

To select and adjust an actuator using the 9-key controller:

1. Push the on/off button to power on the chair and the controller.
2. Push the actuator select button to select actuator 1.
3. Push the joystick forward to lower actuator 1 or backward to raise actuator 1 to the desired position.
4. Push the joystick to the right to select actuator 2.
5. Push the joystick forward to lower actuator 2 or backward to raise actuator 2 to the desired position.
6. Push the joystick to the left to select actuator 1.
7. Push the actuator select button to return to drive mode.

Drive/Function Inhibit

Drive/function inhibit status is indicated by the flashing of the maximum speed/profile lights. Actuator adjustment will affect the inhibit status. As your seat and/or back angle increases, the speed/profile indicator lights will flash continuously to indicate full drive lockout. If your power chair is equipped with a seat lift, the controller may indicate speed reduction as the seat is elevated. To return your power chair to full drive function, reverse operation.



WARNING! Drive/Function Inhibit status is read only during actuator adjustment. This function is disabled in drive mode in order to prevent unintended loss of function in your power chair. Take caution when negotiating obstacles, ramps, and inclines. Whenever possible, use an attendant in these conditions.

WARNING! Operating your power chair on inclines and/or with tilt/recline function will affect your power chair's stability.

Drive Profile Selection

Your VR2 Controller may be programmed for up to five drive profiles that allow the system to be custom tailored to your environment. The selected profile is displayed by the maximum speed/profile indicator.

NOTE: Drive profiles are set by your authorized Pride/Quantum Rehab Provider. Contact your authorized Pride/Quantum Rehab Provider to change a drive profile or change speed settings.

To select a drive profile setting:

1. Push the on/off button to power on the chair and the controller.
2. Push the speed/profile decrease button to go to the previous profile setting.
3. Push the speed/profile increase button to go to the next profile setting.

Speed Adjustment

The VR2 Controller provides a speed/profile decrease button and a speed/profile increase button to control the speed of the power chair. The maximum speed setting is displayed by the maximum speed/profile indicator.

To change the speed:

1. Push the on/off button to power on the chair and the controller.
2. To increase your speed, press the speed/profile increase button.
3. To decrease your speed, press the speed/profile decrease button.

Lock Mode

The controller is equipped with a feature that enables you to “lock out” unauthorized users.

To lock the controller:

1. While the power is on, press and hold the on/off button until it beeps (approximately 1 second.)
2. Release the on/off button.
3. Move the joystick to the full forward position until the controller beeps.
4. Move the joystick to the full rearward position until the controller beeps.
5. Release the joystick. There will be one long beep. The controller system is now locked.

To unlock the controller:

1. Press the on/off button to turn on the controller. The maximum speed/profile indicator will ripple the “locked” sequence.
2. Move the joystick to the full forward position until the controller beeps.
3. Move the joystick to the full rearward position until the controller beeps.
4. Release the joystick. There will be one long beep. The controller system is now unlocked.

Sleep Mode

The VR2 Controller features a sleep mode. Sleep mode is a built-in circuit that will automatically shut off the main power if the joystick is not moved in any direction for a period of time. This time factor is programmed into the controller. To restore power and continue, turn the controller off and then on again.

Thermal Rollback

The VR2 Controller is equipped with a thermal rollback circuit which monitors the temperature of the chair’s motors and controller. If either exceeds the safe operating temperature, the controller reduces the output to 50% of full operation level. This reduces the chair’s speed and allows a cool down period. Once the temperature returns to a safe level, the chair will resume normal operation.

Error Codes

The battery condition meter will flash error codes when the controller system detects an abnormal condition in the electrical system. Error codes are displayed as a rapid flashing of lights on the battery condition meter. The battery condition meter will continue to flash the error codes until the problem is fixed. The following table identifies the individual error codes. If any of these error codes persist, contact your Pride/Quantum Rehab Provider.

Fault Code	Probably Cause	Possible Solutions
1 Flash	The batteries need charging. There is a bad connection to the batteries.	Check the battery connections. If the battery connections are good, then try charging the batteries.
2 Flashes	There is a bad connection on the left motor.	Check the left motor connections and wiring harnesses.
3 Flashes	The left motor has a short to a battery connection.	Contact your Pride/Quantum Rehab Provider.
4 Flashes	There is a bad connection on the right motor.	Check the right motor connections and wiring harnesses.
5 Flashes	The right motor has a short to a battery connection.	Contact your Pride/Quantum Rehab Provider.
6 Flashes	The charge inhibit has been activated.	Make sure that the battery charger is not connected to the power base.
7 Flashes	There is a joystick fault.	Make sure the joystick is in the center position and then power off and on again.
8 Flashes	There is a control system fault.	Check power module and joystick module connections and wiring.
9 Flashes	The park brakes have a bad connection.	Check the left and right motor connections and wiring.
10 Flashes	An excessive voltage has been applied to the control system.	Check the battery connections.

Care and Maintenance

Refer to your power chair owner's manual for proper cleaning and disposal instructions.

Temperature

Some parts of your power chair are susceptible to extreme changes in temperature. Always keep your power chair between the temperatures of 18°F (-8°C) and 122°F (50°C).

Warranty

Refer to your power chair owner's manual for specific information on the controller warranty.

PRIDE[®]

M O B I L I T Y

USA

401 York Avenue
Duryea, PA 18642
www.pridemobility.com

Canada

5096 South Service Road
Beamsville, Ontario L0R 1B3
www.pridemobility.ca

Australia

20-24 Apollo Drive
Hallam, Victoria 3803
www.pridemobility.com.au

New Zealand

Unit 5/208 Swanson Road
Henderson, Auckland 0610
www.pridemobility.co.nz

UK

(Authorised UK Representative)
32 Wedgwood Road
Bicester, Oxfordshire OX26 4UL
www.pride-mobility.co.uk

The Netherlands

(Authorised EU Representative)
De Zwaan 3
1601 MS Enkhuizen
www.pride-mobility.nl
www.pridemobility.eu

Italy

Via del Progresso-ang. Via del Lavoro
Loc. Prato della Corte
00065 Fiano Romano (RM)
www.pride-italia.it

France

26 Rue Monseigneur Ancel
69800 Saint-Priest
www.pridemobility.fr

Spain

Calle Las Minas Número 67
Polígono Industrial Urtinsa II, de Alcorcón
28923 Madrid
www.pridemobility.es

Germany

Hövelrieger Str. 28
33161 Hövelhof
www.pridemobility.de

China

Room 508, Building #4, TianNa Business
Zone
No. 500 Jianyun Road, Pudong New Area
Shanghai 201318
www.pridechina.cn

